

universal

Pizza preparation counters



The UNIVERSAL pizza modular counters were designed to meet the needs of the pizza maker, with unsurpassed efficiency and quality. The construction is entirely in stainless steel, with a bottom cell with rounded corners that allows easy cleaning and maximum hygiene. The refrigerated base units are suitable for the inclusion of 60x40 cm trays and shelves and are equipped with "HSS" static/assisted refrigeration system, a patented system that ensures perfect uniformity of temperature in the cell, a good level of relative humidity in addition to energy savings. The doors have interlocking magnetic seals that are easily replaceable. The worktops are made of Sardinian granite, with a depth of 82 cm and are equipped with rear risers from 16 cm height to support the refrigerated ingredient holder display case (GN trays not included). Equipped with two pairs of runners and one shelf per door.

TECHNICAL DATA:

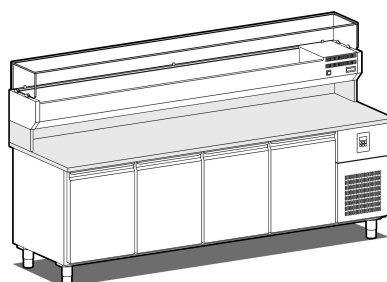

Body	mm
External dimensions (WxDxH)	mm
Capacity	lt
Technical compartment position	
Doors	nr
Neutral drawer on the technical compartment	nr
Neutral drawer unit 4+1 drawers	nr
Evaporators	nr
Equipment (600x400 shelves)	nr
Electronic control	
Temperature	°C
Defrosting type	
Condensate water elimination	
Maximum absorbed power (in defrost phase)*	W
Refrigeration power *	W
Gas	
Voltage supply	
Climatic class	

PC/270

710
2680x820x1500
700
right
4
-
-
2
4
digital by back panel (counter)
+2/+8 (counter) • +2/+8 (display cabinet)
automatic by heating elements (counter)
automatic (counter)
665 (counter) • 155 (display cabinet)
725 (counter) • 145 (display cabinet)
R290
1x230V/50Hz
5



Refrigeration system HSS "Static/Assisted":

- perfect uniformity of cell internal temperature
- good level of relative humidity
- lower energy consumption

*Evap. -10°C cond. +45°C



Refrigerated display cabinet details (GN trays not included)

ACCESSORIES AND SURCHARGES ON REQUEST:



Pair of runners



Rilsan rack 600x400



Plastic cm 60x40x7h pizza container

Plastic cm 60x40 lid



Castor Ø 125 mm

Self-locking castor Ø 125 mm

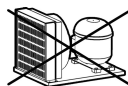

Prearranged version with valve system (deduction)



Wi-Fi supervising system (surcharge)

60Hz frequency





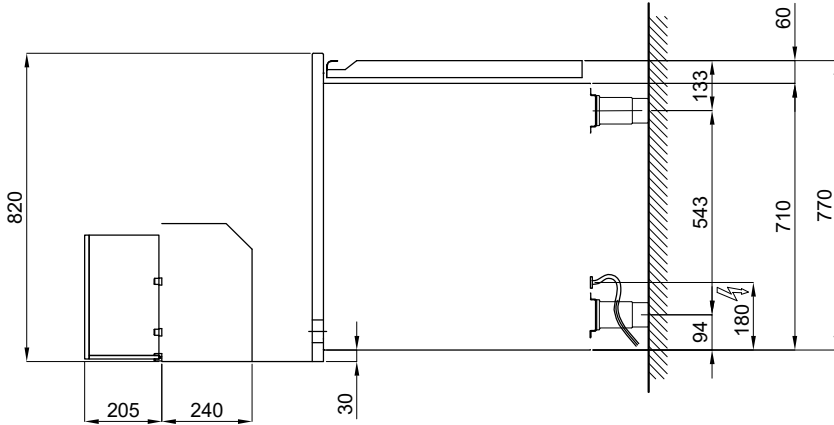

KIT/15 Kit of trays with lids for VRPG/15D

INSTALLATION DIAGRAM:

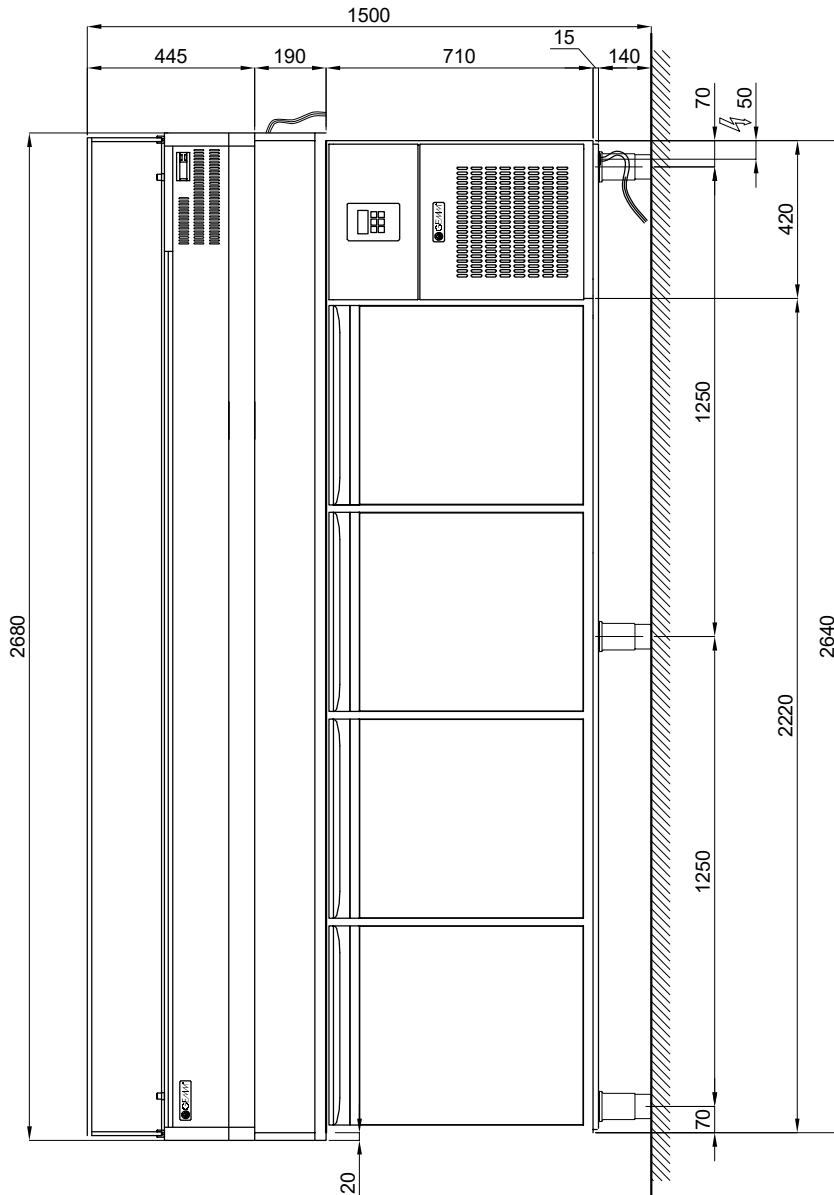
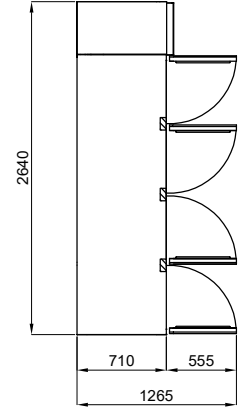

PART.
INGOMBRO PORTE
SCALA 1 : 60



 MAX ABSORBED POWER VRPG / 27 : 155 W
 INPUT VOLTAGE : 230 V ~ 1 - 50Hz (SHUKO plug) - Wire length 1.5 mt
 MAX ABSORBED POWER TBP / 27 : 665 W
 INPUT VOLTAGE : 230 V ~ 1 - 50Hz (* SHUKO plug) - Wire length 2 mt