

# labor

## Prearranged pastry refrigerated counters



Refrigerated and freezer counters of "LABOR" range are designed for 40x60cm trays, the ideal solution for pastry and bakery laboratories. The body is entirely made in s/s steel with rounded corners to ensure easy cleaning and maximum hygiene.

"LABOR" counters are equipped with electronic back panel that allows constant monitoring and control of inside temperature, automatic defrost by heating elements and automatic evaporation of condensate water (excluded models with remote condensing unit).

Besides, they are available with built-in compressor or with remote condensing unit with valve system, in normal temperature version and in low temperature version. 40 mm s/s work tops are reinforced with 15/10 thickness with rounded corners.

Equipment includes no. 7 pairs of runners per door with 75mm pitch.

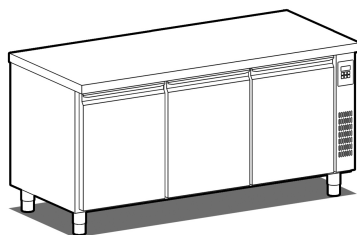

### TECHNICAL DATA:

#### TAPN/18

Body	mm	710	
External dimensions without worktop TAPN/...S (WxDxH)	mm	1790x770x860	
External dimensions with s/s worktop TAPN/...		1800x800x900	
External dimensions with with backsplash TAPN/...A			1800x800x1000
Capacity	lt	525	
Technical compartment position		right	
Doors	nr	3	
Evaporator	nr	1	
Supply (pairs of runners)	nr	21	
Electronic control		digital by back panel	
Temperature	°C	0/+8	
Defrosting type		automatic by heating elements	
Condensate water elimination		manual tray / drain pipe	
Maximum absorbed power (in defrost phase) *	W	350	
Refrigeration power *	W	380	
Valve system		R134a gas	
Voltage supply		1x230V/50Hz	
Climatic class		5	



Refrigeration system HSS "Static/Assisted":

- perfect uniformity of cell internal temperature
- good level of relative humidity
- lower energy consumption

\*Evap. -10°C cond. +45°C



Internal detail



No. 7 pairs of runners per door



Back panel control board



Detail of s/s worktop edge

## ACCESSORIES AND SURCHARGES ON REQUEST:

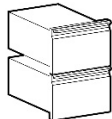

**CRP/2** Refrigerated drawer unit with 2 1/2 drawers (surcharge)

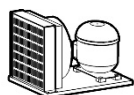

Condensing unit 1/3 Hp

Tray for automatic elimination of condensate water



Pair of runners

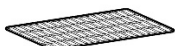

Rilsan rack 60x40 cm

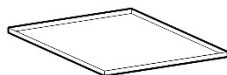

S/s tray 60x40x2h cm  
S/s tray 60x40x3h cm



Castor Ø 125 mm (surcharge)  
Self-locking castor Ø 125 mm (surcharge)



Wi-Fi supervising system (surcharge)

60Hz frequency

INSTALLATION DIAGRAM:

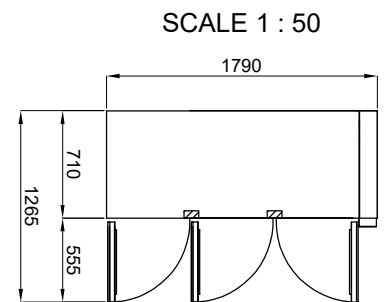
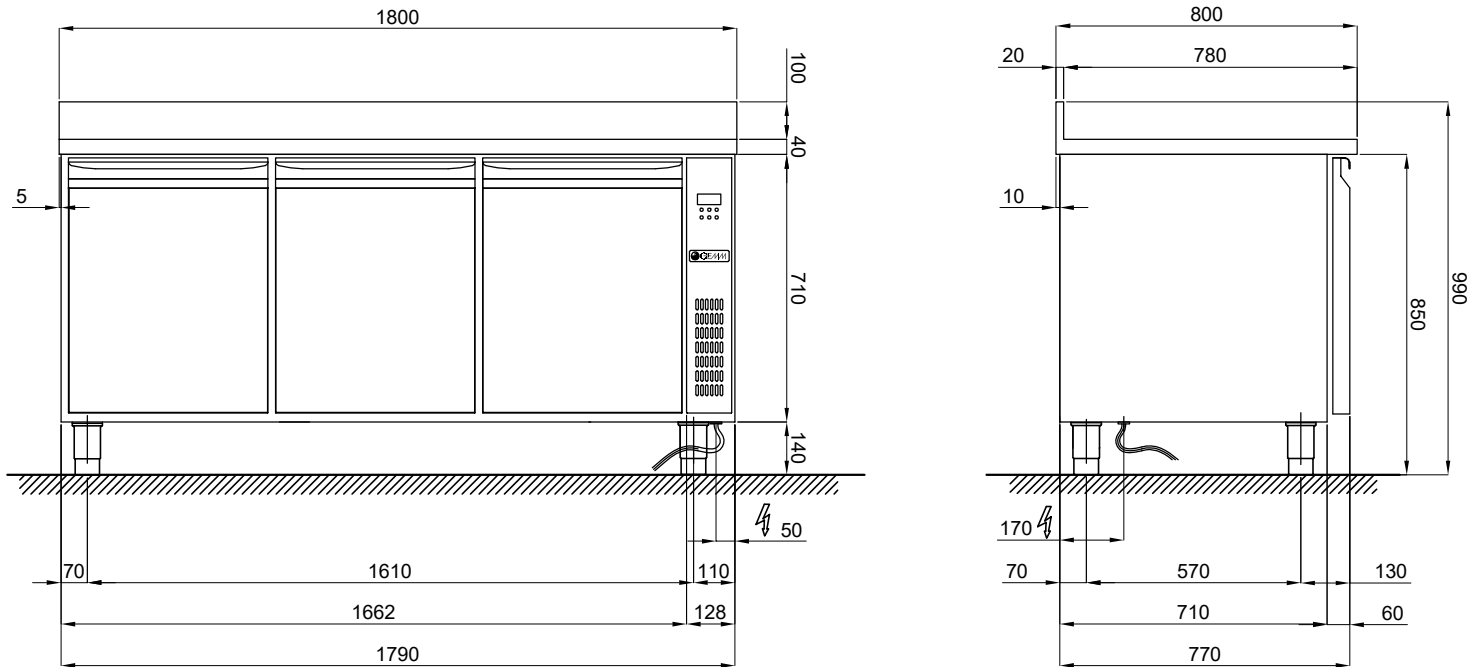

 EL. SUPPLY : 230 V ~ 1 - 50Hz (\* SHUKO plug) - 2 mt wire length