

new smart

GN Pizza Counters



The GEMM pizzeria counters are projected to satisfy all the markets needs and they are equipped with condensing units specially dimensioned to guarantee the perfect conservation of the pizza balls.

The NEW SMART series is a range of pizza counters for pizzeria and fast-food, with reduced overall dimensions.

The NEW SMART counters for pizzeria stand out in particular for the refrigerated base with GN 1/1 gastronorm sizes, granite work top with 16 cm high rear risers and refrigerated display cabinet with independent condensing unit equipped with straight glass shelf.

GN containers not included.

TECHNICAL DATA:

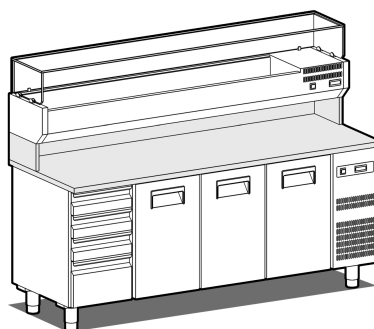

SMR/20C

External dimensions (WxDxH)	mm	2000x720x1500
Capacity	lt	350
Standard fitting (shelves)	nr	3 GN 1/1
Containers capacity of display cabinet	nr	9 GN 1/3
Max absorbed power*	W	200 + 155
Refrigerated power*	W	362 + 280
Chamber internal temperature	°C	+2/+8
Refr. display cabinet internal temperature	°C	+2/+8
Gas		R290
Input voltage		1x230V-50Hz
Climatic class		5

*Evap. -10°C cond. +45°C



ACCESSORIES AND OVERPRICES ON REQUEST:



Pair of runners for GN 1/1 racks

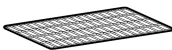

GN 1/1 rack



GN 1/1 plastic pizza container



Castor Ø 125 mm

Self-locking castor Ø 125 mm

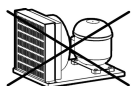

Prearranged version with valve system (deduction)



Wi-Fi supervising system (surcharge)

60Hz frequency



KIT/20

Kit of trays with lids for SMR/20(C)

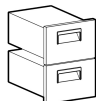

CRE/2

Refrigerated drawer unit with 2 1/2 drawers (overprice)

INSTALLATION DIAGRAM:

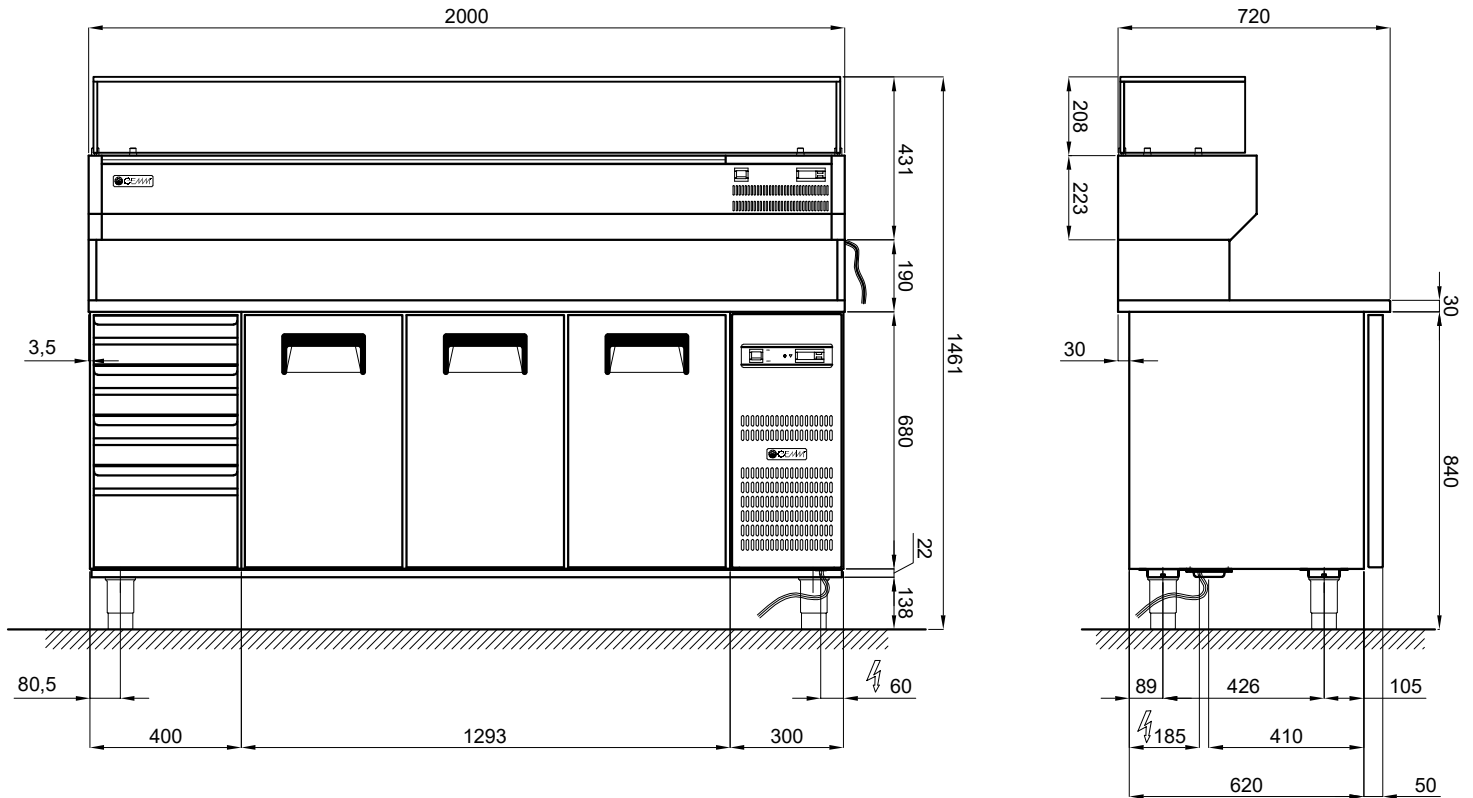

DOORS SIZE
SCALE 1:50

 INPUT VOLTAGE : 230 V ~ 1 - 50Hz (*SHUKO plug) - Wire length 1.5 mt

 INPUT VOLTAGE : 230 V ~ 1 - 50Hz (*SHUKO plug) - Wire length 2 mt

