

new smart

Tavoli Fast Food



La serie NEW SMART è una nuova gamma di tavoli di preparazione per locali pizzerie e fast-food, con dimensioni di ingombro molto contenute.

I banchi refrigerati fast-food, ideali per la preparazione di insalate e panini, hanno profondità 700 e 800 mm, con dimensioni interne rispettivamente GN 1/1 e cm 40x60. Sono dotati di coperchio inox con guarnizione e piano di lavoro in acciaio inox o granito sardo.

Bacinelle GN escluse

DATI TECNICI:

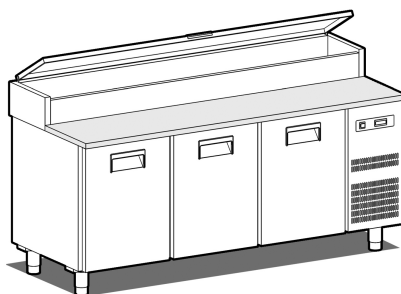

SFF/820I (G)

Dimensioni esterne (WxDxH)	mm	2020x820x1040
Capacità	lt	540
Dotazioni (griglie)	nr	3 60x40
Capacità bacinelle elem. portabacinelle	nr	10 GN 1/3
Potenza max assorbita *	W	160
Potenza refrigerante *	W	185
Temperatura tavolo refrigerato	°C	+2/+8
Gas		R290
Tensione alimentazione		1x230V-50Hz
Classe climatica		5

*Evap. -10°C cond. +45°C



ACCESSORI E MAGGIORAZIONI A RICHIESTA:



Coppia guide 60x40

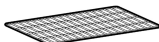

Griglia 60x40

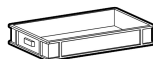

Contenitore portapizze in plastica 60x40



Ruota pivotante Ø 125 mm



Ruota autobloccante Ø 125 mm

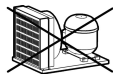

Versione predisposta con impianto a valvola (detrazione)



Sistema supervisione Wi-Fi (maggiorazione)



Frequenza 60Hz



KIT/20FF

Kit nr. 10 bacinelle GN 1/3 per SFF/820I(G)



CRPE/2

Cassettiera refrigerata a 2 cassetti 1/2

SCHEMA DI INSTALLAZIONE:

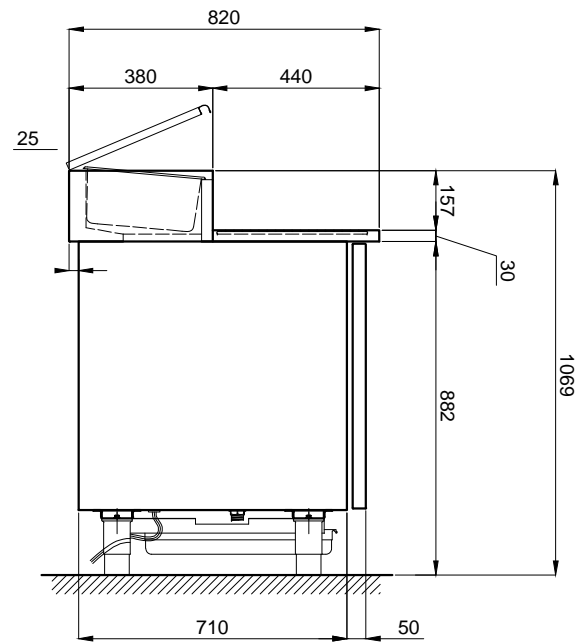
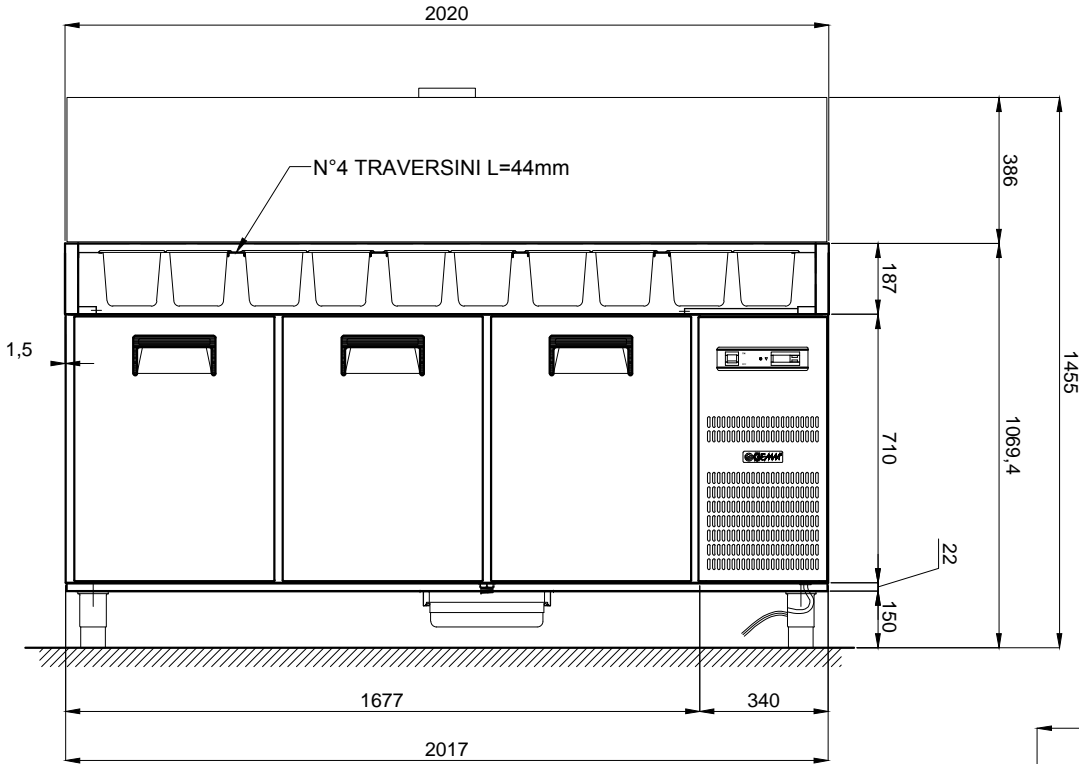

PART.
INGOMBRO PORTE
SCALA 1 : 50

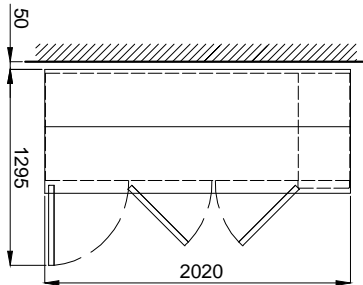

ALIMENTAZIONE : 230 V ~ 1 - 50Hz (* spina SHUKO) - Lunghezza cavo 2 mt