

new smart

Fast Food Counters



The NEW SMART series is a range of pizza counters for pizzeria and fast-food, with reduced overall dimensions.

The refrigerated counters for fast-food are ideal for the preparation of salads and sandwiches. They are available with 2 or 3 doors, 700 and 800 mm deep with internal dimensions respectively GN 1/1 and cm 40x60. The refrigerated tray holder, suitable to house GN trays, is equipped with stainless steel lid with sealing for perfect closing. Work tops can be supplied in stainless steel or in granite. GN containers not included.

TECHNICAL DATA:

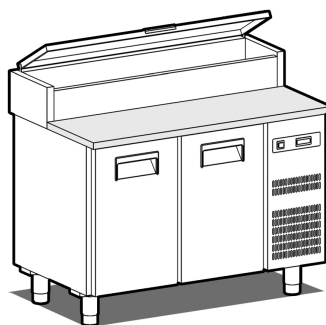

SFF/712I (G)

External dimensions (WxDxH)	mm	1200x720x1040
Capacity	lt	230
Standard fitting (shelves)	nr	2 GN 1/1
Containers capacity of display cabinet	nr	6 GN 1/3
Max absorbed power*	W	160
Refrigerated power*	W	145
Chamber internal temperature	°C	+2/+8
Gas		R290
Input voltage		1x230V-50Hz
Climatic class		5

*Evap. -10°C cond. +45°C



ACCESSORIES AND OVERPRICES ON REQUEST:



Pair of runners for GN 1/1 racks

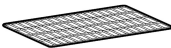

GN 1/1 rack

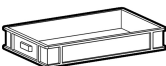

GN 1/1 plastic pizza container



GN 1/1 plastic lid



Castor Ø 125 mm



Self-locking castor Ø 125 mm

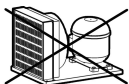

Prearranged version with valve system (deduction)



Wi-Fi supervising system (surcharge)

60Hz frequency



KIT/12FF

Kit of nr. 6 GN 1/4 trays for SFF/712I(G)

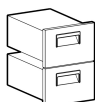

CRE/2

Refrigerated drawer unit with 2 1/2 drawers (overprice)

INSTALLATION DIAGRAM:

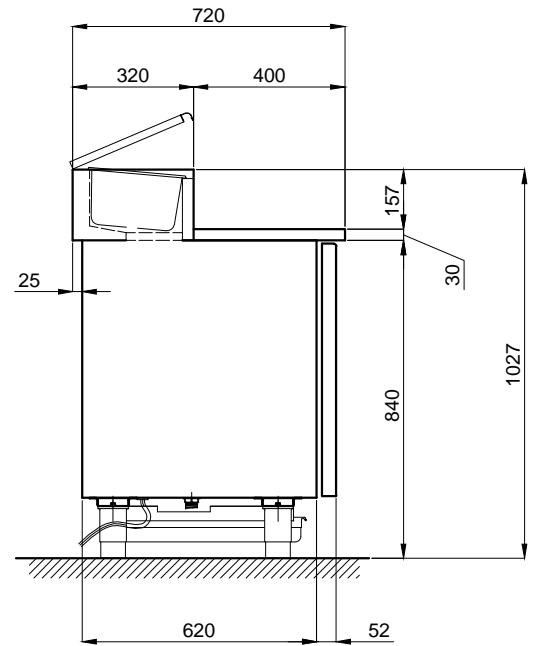
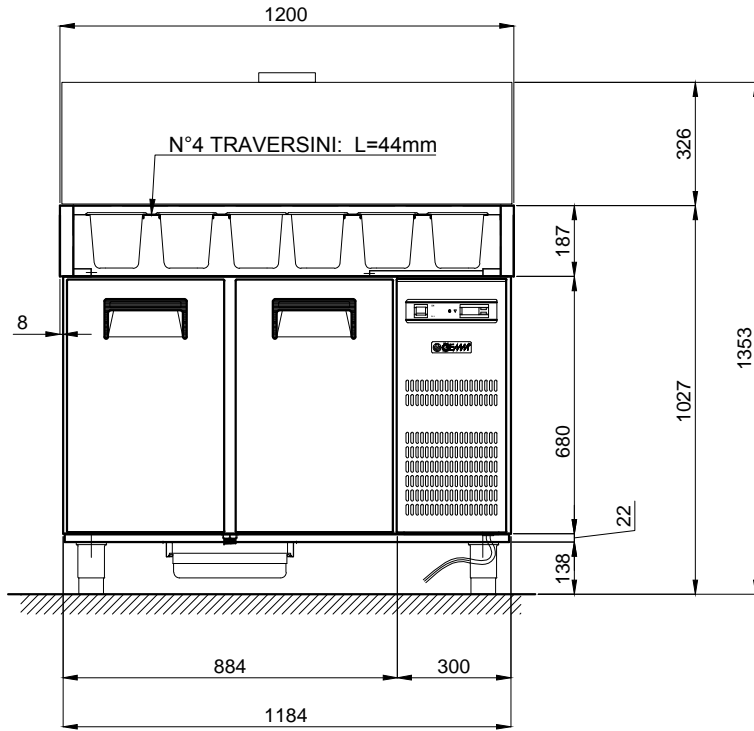

DOORS SIZE
SCALE 1 : 50

 INPUT VOLTAGE : 230 V ~ 1 - 50Hz (*SHUKO plug) - Wire length 1.5 mt

 INPUT VOLTAGE : 230 V ~ 1 - 50Hz (*SHUKO plug) - Wire length 2 mt

